

CONTENTS

GENERAL INTRODUCTION TO B&G NETWORK	2	USING THE LIGHTS KEY	17
INTRODUCTION TO NETWORK DEPTH	3	SETTING THE DISPLAY LANGUAGE	18
EXAMPLE SYSTEMS USING NETWORK DEPTH	4	NETWORK ALARMS	19
SELECTING THE DISPLAY MODE	5	FAULT AND ERROR MESSAGES	20
USING THE DEPTH KEY	6	INSTALLATION	21
SETTING THE DEPTH UNITS	7	SITING THE UNIT	21
THE DEPTH DATUM - D CAL	8	MOUNTING THE UNIT	21
SETTING THE DEPTH DATUM	9	SPECIFICATION	23
USING THE SIGNAL KEY	10	CONDITIONS OF WARRANTY	
USING THE ALARM KEY	11		
DEPTH ALARMS	11		
ENABLING/DISABLING THE SHALLOW ALARM	12		
ADJUSTING THE SHALLOW ALARM VALUE	12		
ENABLING/DISABLING THE DEEP ALARM	13		
ADJUSTING THE DEEP ALARM VALUE	13		
THE ANCHOR ALARM	14		
ENABLING/DISABLING THE ANCHOR ALARM	15		
ADJUSTING THE ANCHOR ALARM LOW LIMIT	16		
ADJUSTING THE ANCHOR ALARM HI LIMIT	16		

GENERAL INTRODUCTION TO B&G NETWORK

The B&G Network range of instruments are designed to be used as individual units or connected together to form an integrated navigational system. A single network cable is used to carry data and power between units. The latest technology and screened cables throughout the Network System ensure the ultimate protection from interference between units and other systems.

All Network instruments can be linked to Network PILOT, Network CHART, Network GPS or Network LORAN receivers or via NMEA 0183 (v1.5) to other navigational equipment.

INSTRUMENTS

- Network SPEED
- Network DEPTH
- Network QUAD
- Network WIND
- Network TACK
- Network DATA

NAVIGATIONAL AIDS

- Network NAV
- Network GPS
- Network LORAN
- LCD CHART

AUTOPILOTS

- Network PILOT

INTRODUCTION TO NETWORK DEPTH

The Network DEPTH unit measures and displays Depth information on a large Liquid Crystal Display (LCD). The five keys allow selection of the displayed information and setting of the units mode, calibration factors and alarms.

It can operate as the main Network DEPTH unit either alone or as part of an Integrated Network Instrument System taking inputs directly from a Depth Sensor that plugs directly into the rear of the display. It will also operate as a repeater of depth information received via the two Network cable tails.

The Network Depth unit has three adjustable alarms:

1. Shallow water alarm
2. Deep water alarm
3. Anchor alarm

An internal alarm buzzer will sound when an alarm condition is met and the display will flash. The alarm is broadcast to all other Network Instruments in an integrated system, they will also sound their alarms and flash their displays (except Network WIND). The Network DEPTH unit will also indicated Network PILOT alarms and fault conditions.

NETWORK DEPTH DISPLAY UNIT

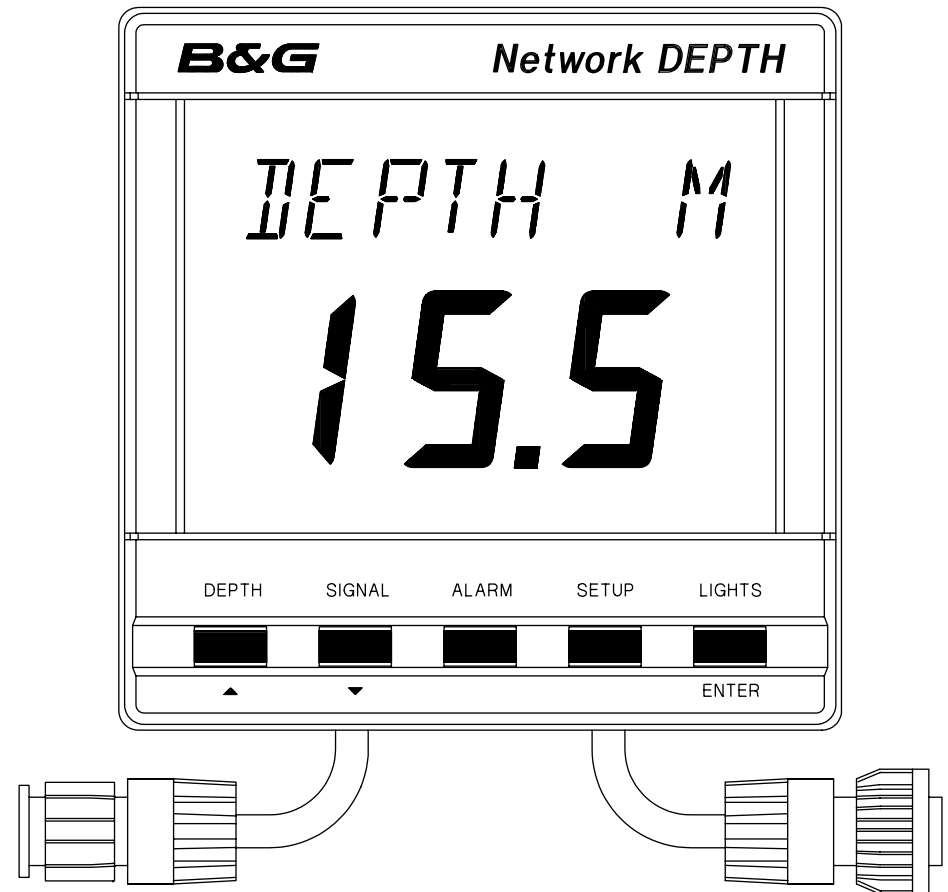

EXAMPLE SYSTEMS USING NETWORK DEPTH

Only one Network DEPTH unit should have a depth sensor connected to it and set to transducer mode. Up to three more Network DEPTH units can be connected on to the system network, these must be set to repeater mode. See SELECTING THE DISPLAY MODE.

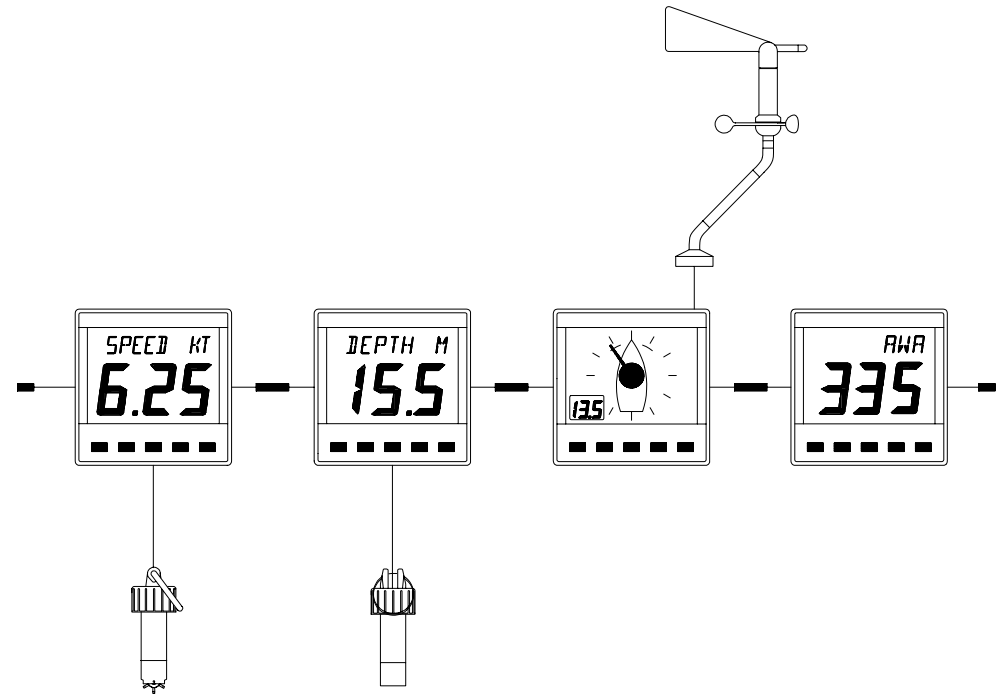
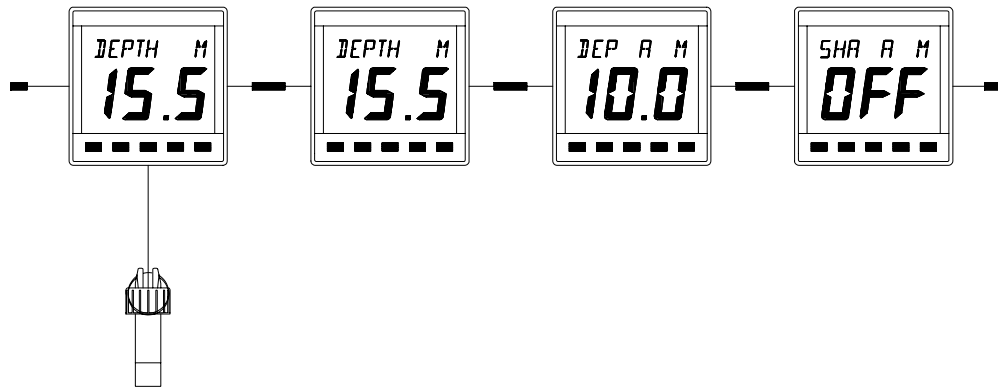

When in repeater mode, if the data is not being received from the system network, the display will show OFF when a key is pressed.

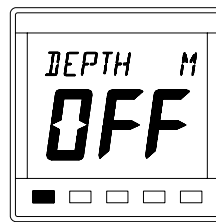

rEP Repeater mode, the unit operates as a depth repeater using data from the system network.

SELECTING THE DISPLAY MODE

The Network DEPTH unit has two operating modes. The correct mode must be selected for your network system to operate properly.

trA Transducer mode, the unit uses and displays depth data from a depth sensor connected directly into the display unit.

rEP Repeater mode, the unit operates as a depth repeater using data from the system network.

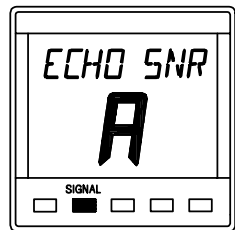

Press **SIGNAL** key.

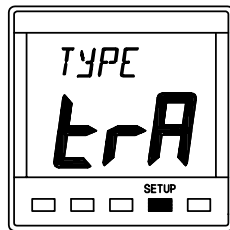

Press **SETUP** key to display the current mode.

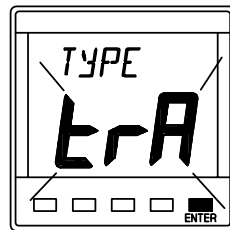

Press **ENTER** key if the mode needs to be changed.

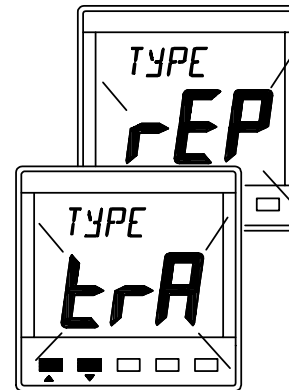

Use ▲ or ▼ to change mode.

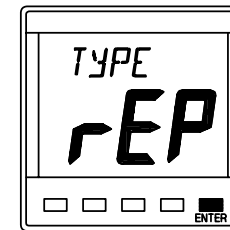

Press **ENTER** to memorise the new mode.

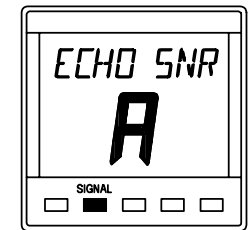

Press **SIGNAL** key to complete the change.

USING THE DEPTH KEY

Press the DEPTH key to cycle through the following options:

- **DEPTH M** The current water depth in metres M, can also be displayed in feet FT or fathoms FA. The unit is factory set to metres. The depth displayed is from the depth datum, see below.
- **D CAL M** The Depth Datum can be adjusted so the displayed water depth is from the water- line, the depth sensor (transducer) or the keel/outdrive depth. The unit is factory set to display water depth from the transducer.

The Network DEPTH unit can measure and display water depth in the following ranges:

- 0.7 to 180 metres
- 2'4" to 590'
- 0.37 to 98.4 fathoms
- Accuracy $\pm 2\%$ or $\pm 0.2\text{m}$ ($\pm 8"$)

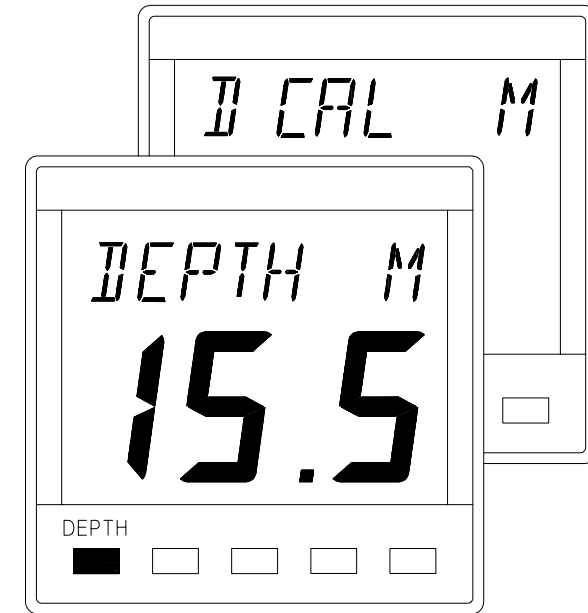

If the Network DEPTH unit loses valid depth data, due either the actual depth being outside the working range, or to extreme turbulence in the water the LCD will show 3 "floating" bars. This shows that the unit is attempting to calculate the depth and is still functioning.

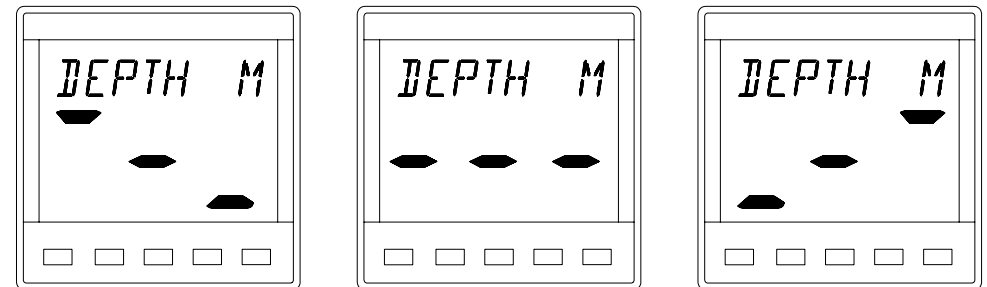

SETTING THE DEPTH UNITS

The Network DEPTH unit can be set to display depth in Metres M, Feet FT or Fathoms FA. The selected units are used for displayed depth information on all Network instruments on the entire network system.

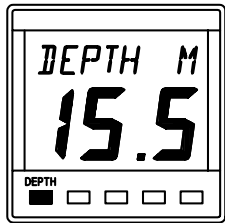

Press **DEPTH** key to display the current depth.

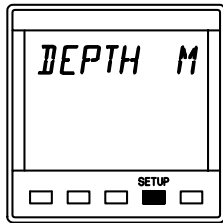

Press **SETUP** key. The depth display will go blank.

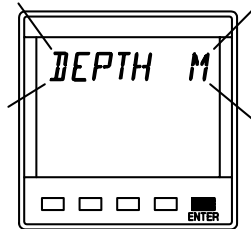

Press **ENTER** key if the units are to be changed.

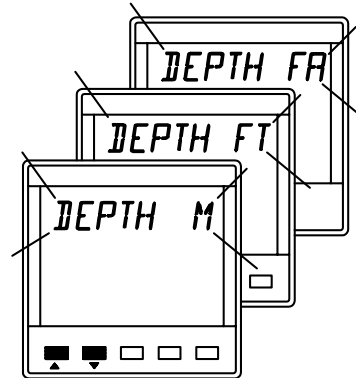

Use **▲** or **▼** to change the units.

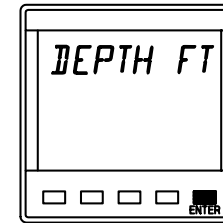

Press **ENTER** key to memorise the change.

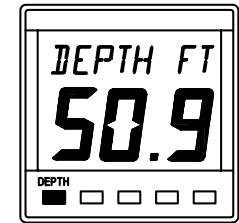

Press **DEPTH** to display current depth.

THE DEPTH DATUM - D CAL

The depth datum **D CAL** is an offset calibration value used to determine the displayed information reference point. It is added to the actual measured water depth to display the depth from the waterline, the depth sensor (transducer) or the keel/outdrive depth.

The Network DEPTH unit has factory set **D CAL** of zero, i.e. the depth is displayed from the transducer. The **D CAL** value is displayed in the same units as the depth.

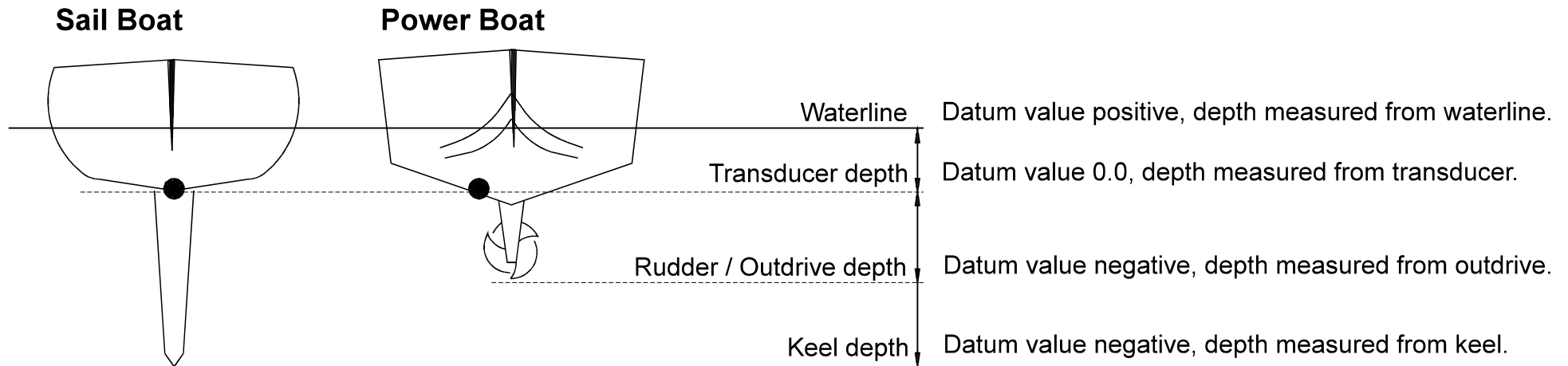

SETTING THE DEPTH DATUM

D CAL zero, depth from transducer **CAL TRA**.

D CAL positive, depth from waterline **CAL W/L**.

D CAL negative, depth from keel **CAL KEEL**.

NOTE: If the CAL LOCK is set then the D CAL value cannot be changed.

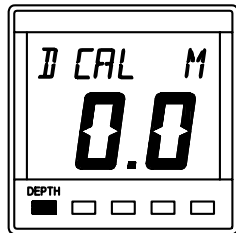

Press **DEPTH** key to display depth datum **D CAL M**.

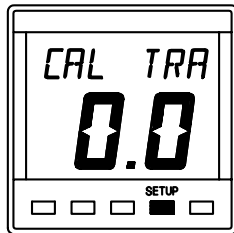

Press **SETUP** key to display current datum value.

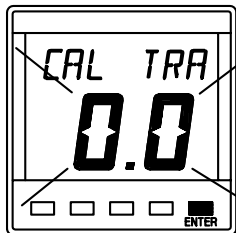

Press **ENTER** to adjust the datum value.

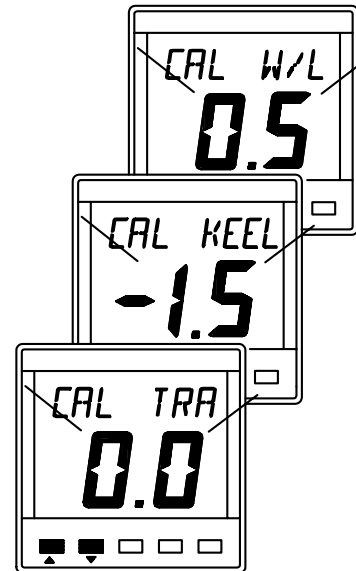

Use **▲** or **▼** to adjust the value.

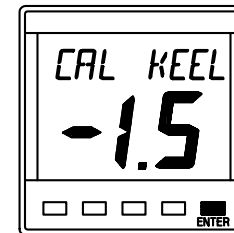

Press **ENTER** to memorise the new value.

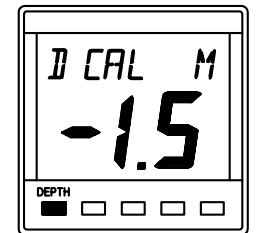

Press **DEPTH** to display the depth datum.

USING THE SIGNAL KEY

Press the **SIGNAL** key to display a letter of merit from **A** to **F**, this is an indication of the return echo strength. **A** is excellent, **F** is poor.

The sea bed can have an effect on the quality of the return echo strength, i.e. very good echoes are returned from rock, shale and sand, however poor echoes are returned from mud. Therefore the merit letter could be **A** or **B** for rocks but **C** or **D** for mud.

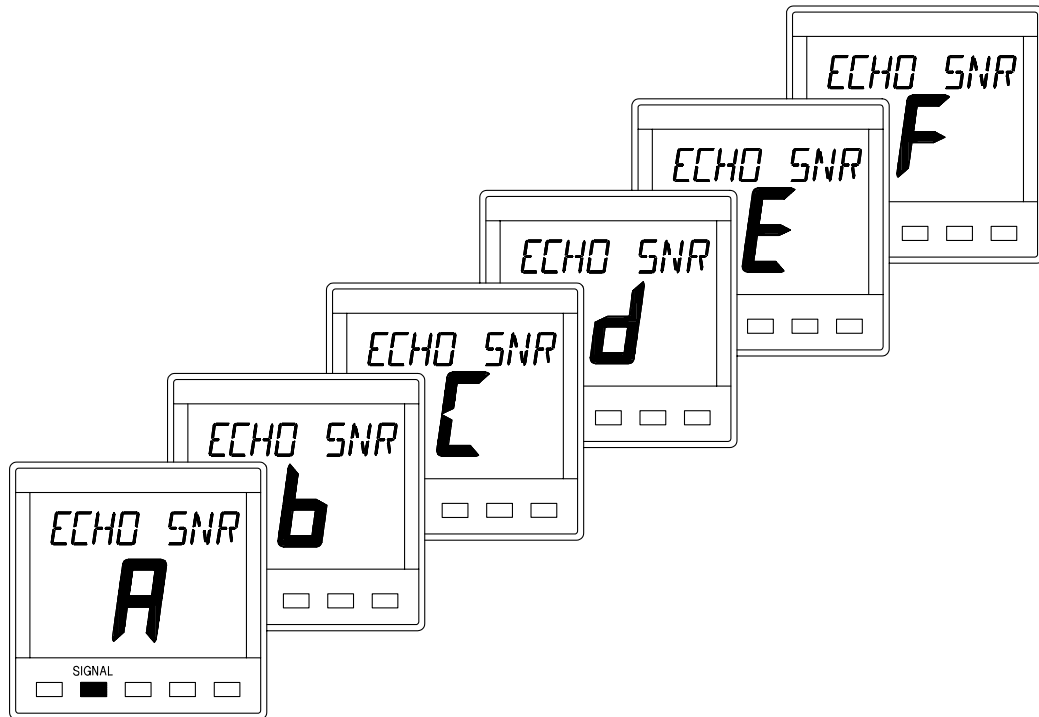

DEPTH ALARMS

Press the **ALARM** key to cycle through the following options:

SHA A M Shallow Alarm, when enabled it will sound if the water depth is less than the alarm value.

DEP A M Deep Alarm, when enabled it will sound if the water depth is more than the alarm value.

ANC A M Anchor Alarm, when enabled it will sound if the water depth is outside two alarm limits.

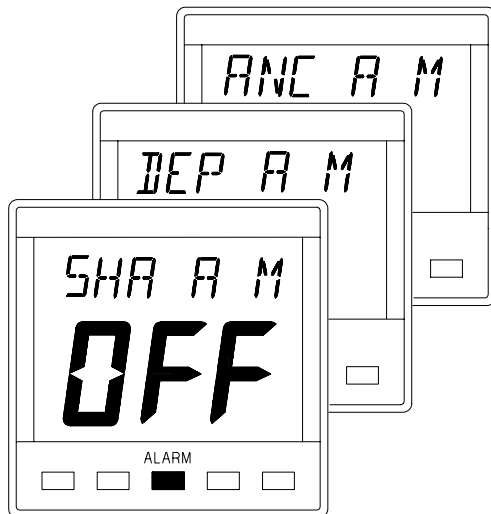

The display will show **OFF** if the alarm is disabled or the alarm value when enabled. The value will be displayed in metres **M**, feet **FT** or fathoms **FA** depending on the selected depth units.

When the alarm condition is met the unit will sound its internal alarm buzzer and flash **DEPTH M**. Silence the alarm by pressing any key.

Shallow Alarm

Factory set to 1.0m, (3.2ft, 0.5 fathoms).
Range 0 - 180m, 0 - 590ft, 0 - 98.4 fathoms.

Deep Alarm

Factory set to 10.0m, (32.8ft, 5.4 fathoms).
Range 0 - 180m, 0 - 590 ft,
0 - 98.4 fathoms.

Anchor Alarm

Factory set **LOW** 0.5m **HI** 1.0m,
(1.6/3.2ft, 0.2/.5 fathoms).
Range 0 -180m, 0 - 590 ft,
0 - 98.4 fathoms.

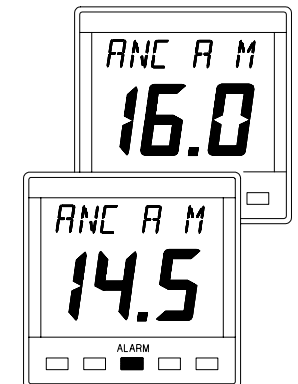

ENABLING/DISABLING THE SHALLOW ALARM



Press **ALARM** key to display shallow alarm *SHA A M*.

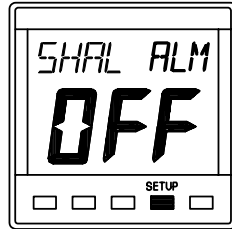

Press **SETUP** key, the alarm state will be displayed.

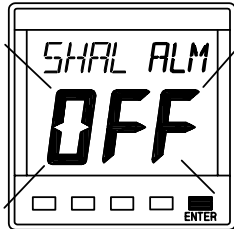

Press **ENTER** key, the display will flash.

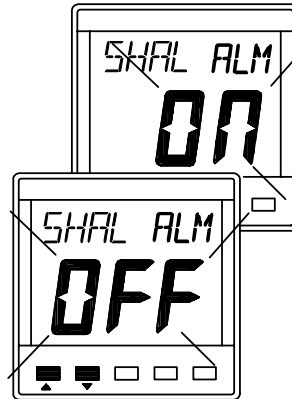

Use ▲ or ▼ to enable/disable the alarm.

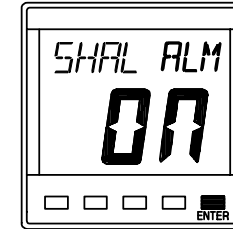

Press **ENTER** to memorise the change.

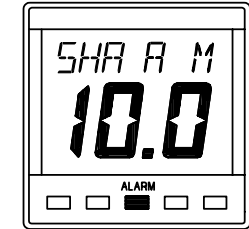

Press **ALARM** key, the value is displayed.

ADJUSTING THE SHALLOW ALARM VALUE

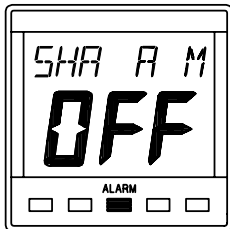

Press **ALARM** key to display shallow alarm *SHA A M*.

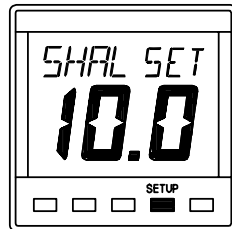

Press **SETUP** key twice, the value is displayed.

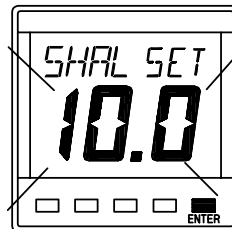

Press **ENTER** key, the display will flash.

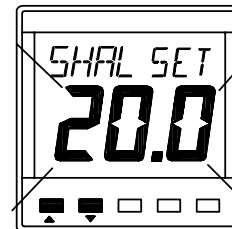

Use ▲ or ▼ to adjust the value.

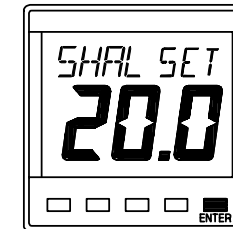

Press **ENTER** key to memorise the new value.

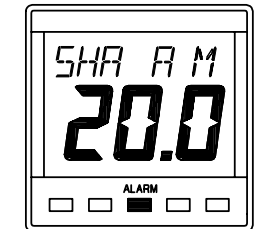

Press **ALARM** key, the alarm is displayed.

ENABLING/DISABLING THE DEEP ALARM

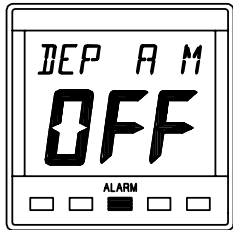

Press **ALARM** key to display deep alarm *DEP A M*.

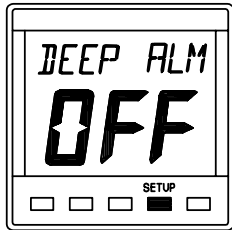

Press **SETUP** key, the alarm state will be displayed.

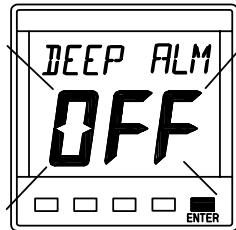

Press **ENTER** key, the display will flash.

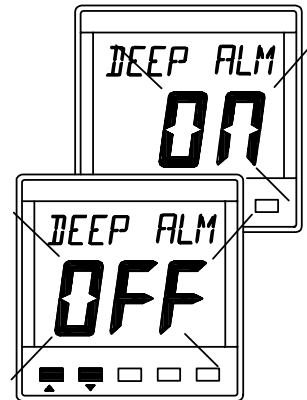

Use **▲** or **▼** to enable/disable the alarm.

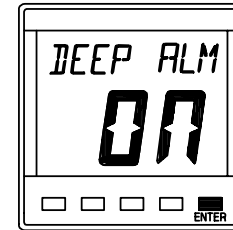

Press **ENTER** to memorise the change.

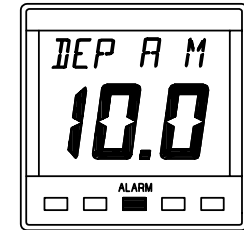

Press **ALARM** key, the value is displayed.

ADJUSTING THE DEEP ALARM VALUE

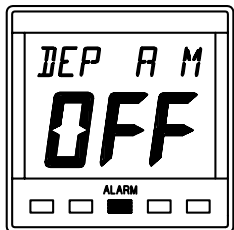

Press **ALARM** key to display shallow alarm *DEP A M*

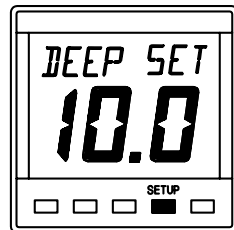

Press **SETUP** key twice, the value is displayed.

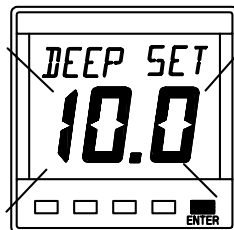

Press **ENTER** key, the display will flash.

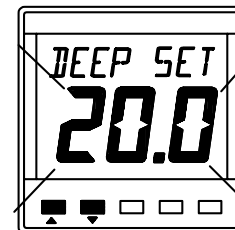

Use **▲** or **▼** to adjust the value.

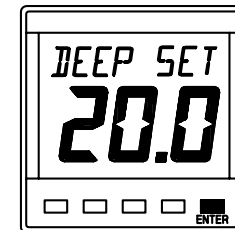

Press **ENTER** key to memorise the new value.

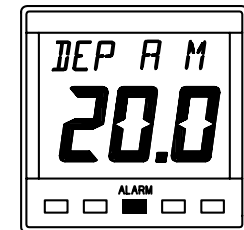

Press **ALARM** key, the alarm is displayed.

USING THE ANCHOR ALARM

The Anchor Alarm uses two adjustable alarm limits. The alarm will sound if the water is deeper or shallower, by the amount set, than the original depth when the alarm was enabled. This allows you to adjust your anchor chain according to the rise and fall of the tides. The Network DEPTH unit has a factory set low limit of 0.5m and a high limit of 1.0m.

In the following example the original water depth was 3m when the alarm was enabled. Using the factory set values, the water depth could increase to 4m (3m + 1m) and decrease to 2.5m (3m - 0.5m) before the alarm would sound.

The anchor alarm depth limits are shown alternatively when they are enabled and displayed using the **ALARM** key.

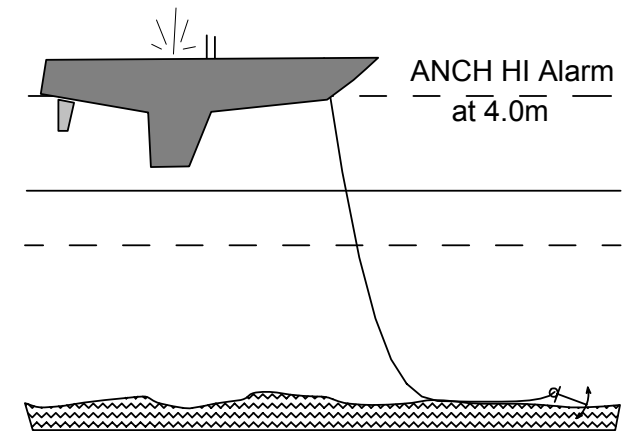
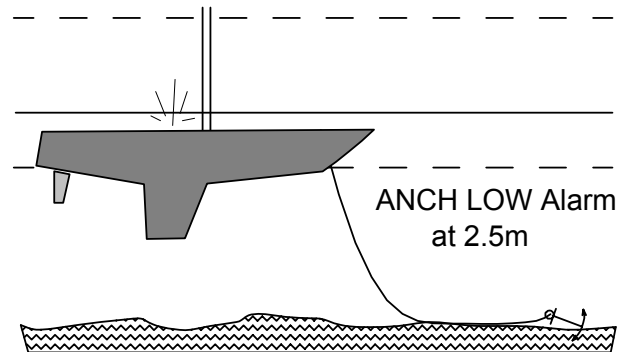
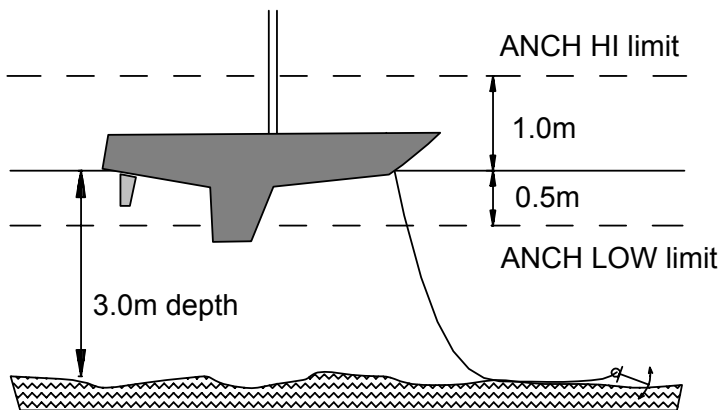
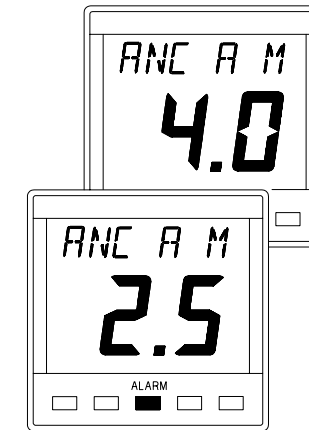

ENABLING/DISABLING THE ANCHOR ALARM



Press **ALARM** key to display anchor alarm **ANC A M**

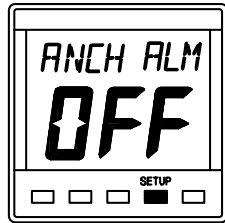

Press **SETUP** key, the alarm state will be displayed.

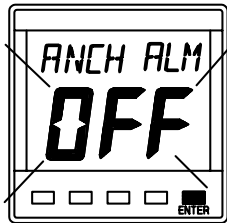

Press **ENTER** key, the display will flash.

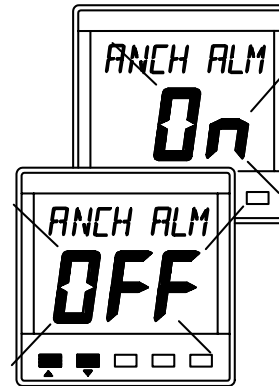

Use ▲ or ▼ to enable/disable the alarm.

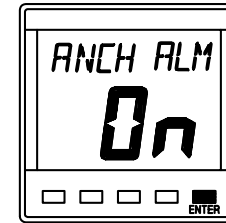

Press **ENTER** to memorise the change.

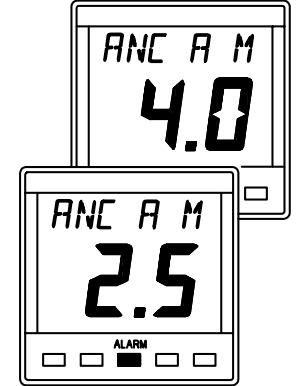

Press **ALARM** key, to display the anchor alarm.

ADJUSTING THE ANCHOR ALARM LOW LIMIT



Press **ALARM** key to display anchor alarm **ANC A M**.

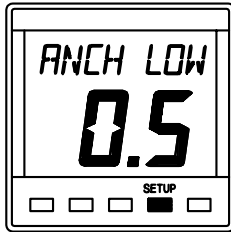

Press **SETUP** key twice to display **ANCH LOW** value.

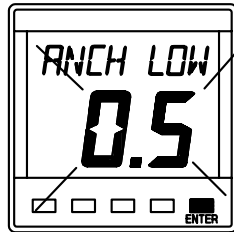

Press **ENTER** key, the display will flash.

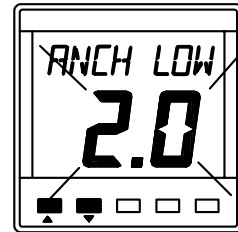

Use **▲** or **▼** to adjust the displayed value.

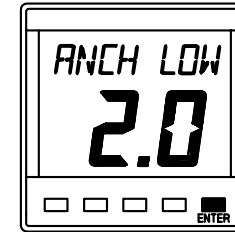

Press **ENTER** to memorise the new value.

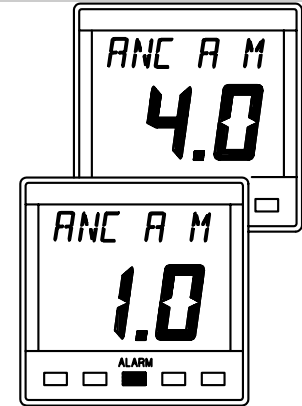

Press **ALARM** key to display the anchor alarm.



Press **ALARM** key to display anchor alarm **ANC A M**.

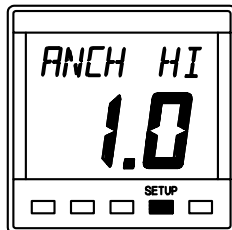

Press **SETUP** key 3 times to display **ANCH HI** value.

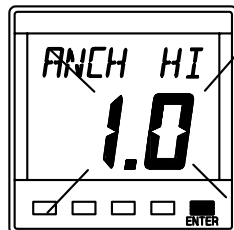

Press **ENTER** key, the display will flash.

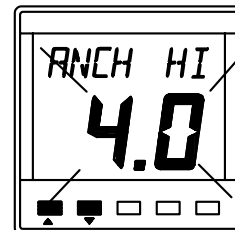

Use **▲** or **▼** to adjust the displayed value.

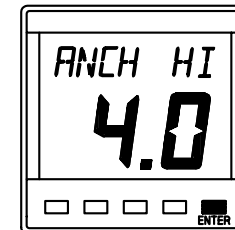

Press **ENTER** key to memorise the new value.

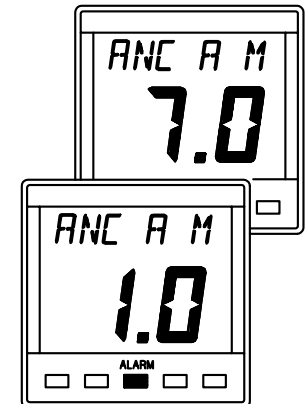

Press **ALARM** key to display the anchor alarm.

USING THE LIGHTS KEY

The Network DEPTH Display unit has 3 levels of illumination and off, controlled by the **LIGHTS** key. It also changes the illumination level of the key legends.

The **LIGHTS** key is always illuminated so even in complete darkness the key can be located.

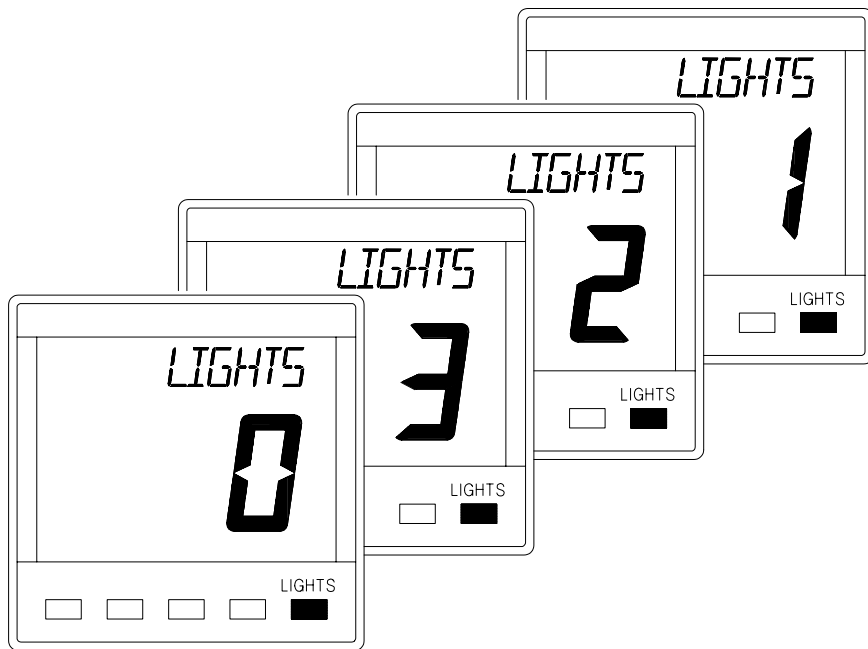

- **LIGHTS 0** OFF
- **LIGHTS 3** High
- **LIGHTS 2** Medium
- **LIGHTS 1** Low

SETTING THE DISPLAY LANGUAGE

The Network DEPTH unit can show LCD text in English or French. To change the display language proceed as follows.

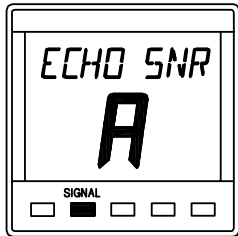

Press **SIGNAL** key.

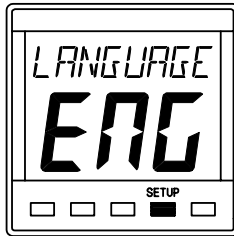

Press **SETUP** key twice to display the language setting.

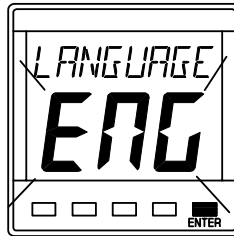

Press **ENTER** key if the language needs to be changed.

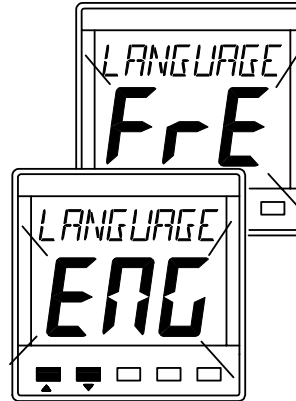

Use ▲ or ▼ to change the language.

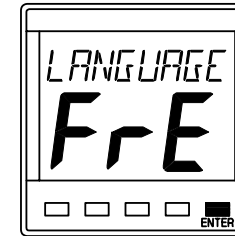

Press **ENTER** to memorise the new setting.

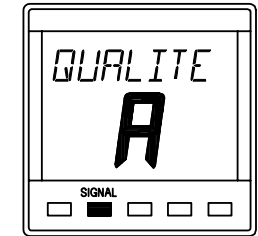

Press **SIGNAL** key to complete the change. The LCD now shows French text.

NETWORK ALARMS

The Network DEPTH unit has an internal buzzer that will sound when an alarm condition is met on a Network unit that has alarm functions ie. Network DEPTH and Network QUAD for depth alarms and Network PILOT for Watch Alarm and Off Course alarms. The unit will also display which alarm is activated.

To silence the internal alarm and return the display to normal operation press any of the five keys.

DEPTH ALARM DISPLAY

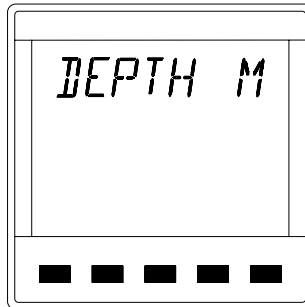

Depth alarms can be set for the following:

- Shallow water
- Deep water
- Anchor Watch

Check your Network DEPTH or QUAD unit to see which alarm is activated.

NETWORK PILOT ALARM DISPLAYS

The Watch Alarm is a count-down timer with is activated at the end of the preset count-down period. The display alternates between the messages below.

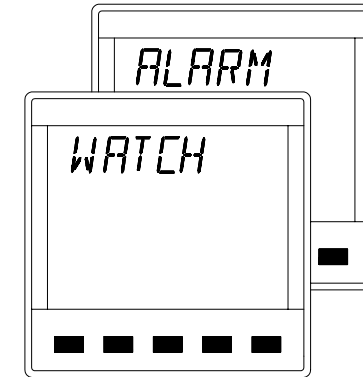

The Off Course alarm is activated when the boat deviates off course by a preset amount. The display alternates between the messages below:

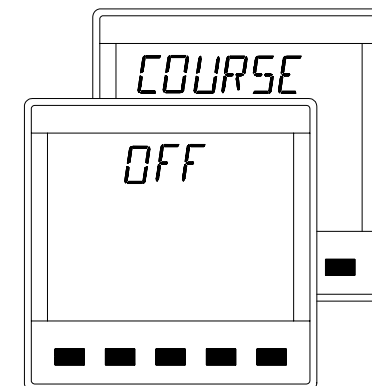

FAULT AND ERROR MESSAGES

NETWORK PILOT FAULT DISPLAY

If Network PILOT should have a fault the autopilot computer unit will send a message to all other Network Display Units. The Network DEPTH unit will alternately display the follow message, the actual fault will have to read from the Network PILOT Display unit.

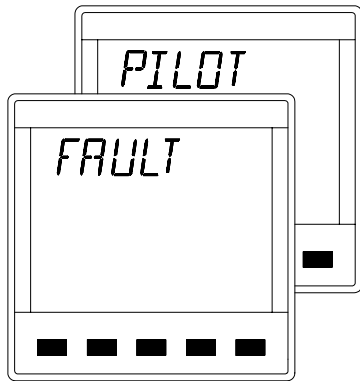

UNIT INTERNAL ERRORS

In the unlikely event that your Network DEPTH unit should develop an internal error, the unit will sound it's alarm continuously and the display will show an error number.

Press any of the keys to reset the error condition and silence this alarm. In some cases the fault can be cleared by switching off the instruments at the supply, waiting a few moments and then switching on again. If either of these methods do not clear the fault the error number should be recorded. Switch off the supply and disconnect the faulty unit. Return it with the error number to your dealer for servicing.

INSTALLATION

The display heads are supplied with a clip-in mounting bracket which allows for easy installation, access from behind is not necessary to secure the unit in place. However to prevent theft and permanently fix the unit in position, locking studs and thumb nuts are supplied.

SITING THE UNIT

All Network Instruments are designed for mounting on or below deck. A mounting position should be selected where they are:

- Easy to read by the helmsman
- On a smooth and flat surface
- At least 100mm (4") from a compass
- Accessible from behind for fitting locking studs if required.

MOUNTING THE UNIT

Use the cutting template supplied to mark the centres of the holes for the self-tapping screw, the fixing stud holes and the mounting bracket.

- The template allows 4mm (5/32") between adjacent units for the suncover, increase this distance if required to maximum of 60mm (2 3/8") between units or 180mm (3 1/8") between centres. For greater distances between units extension cables are available.
- Use a 70mm (2 3/4") diameter hole-cutter for the mounting bracket hole.
- Use a 2.9mm for the self-tapping screw holes. Use a 5mm (3/32") drill for the locking stud holes.
- Secure the mounting bracket to the bulkhead with the self-tapping screws supplied
- Fit the rubber sealing gasket around the mounting bracket.
- Screw the locking studs into the back of the display head (if required).
- Carefully pass the cable tails through the mounting bracket hole, connect the cables to the main units.
- Clip the display head into the mounting bracket.
- Secure the instrument with the thumb nuts supplied.

INSTALLATION DATA

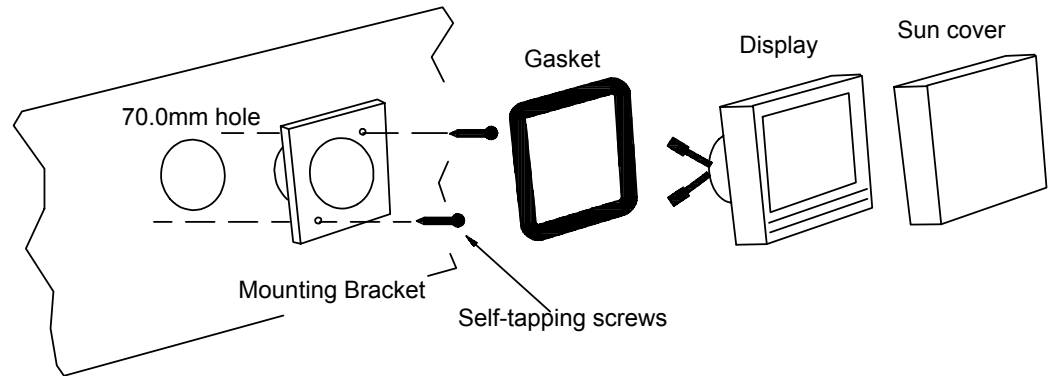
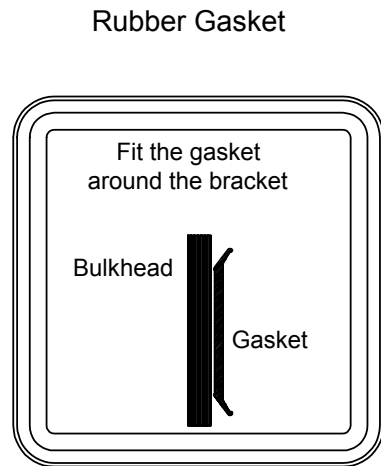
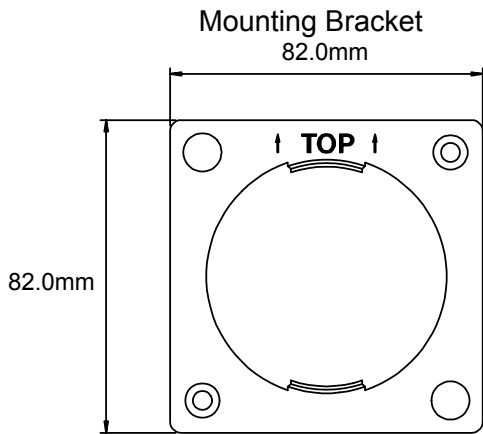
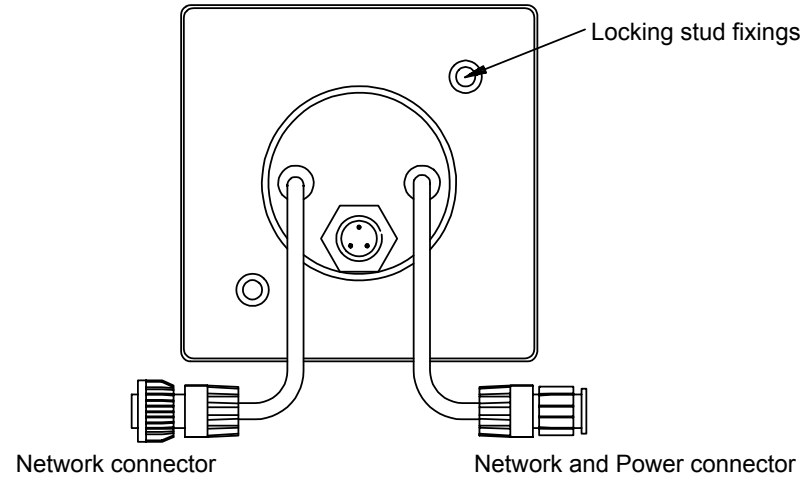
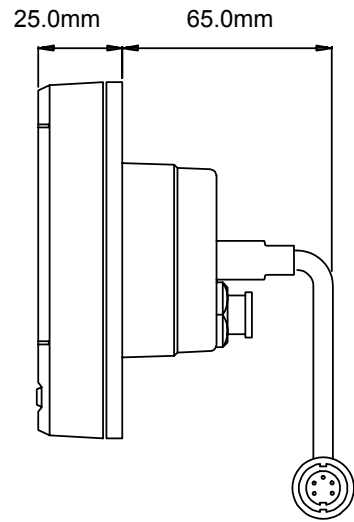
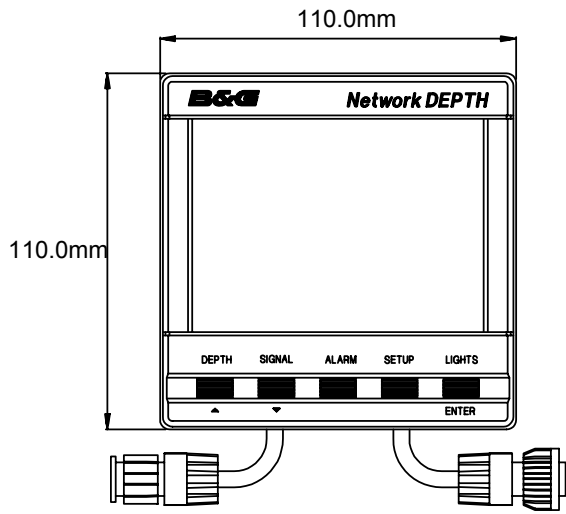

SPECIFICATION

PHYSICAL PARAMETERS

Construction	High impact ABS plastic
Window	Acrylic
Display	Back-lit Liquid Crystal Display: Large Digits: 28.6mm 1.12" Small Digits: 11.5mm 0.45"
Dimensions:	110 x 110 x 25.4mm 4 x 4 x 1" Requires 65mm 2.6" depth behind bulkhead for display barrel
Weight:	0,3 Kg 0.66lbs

ENVIRONMENTAL

Operating Temp	-10 à+55°C, +14 to +1310F @ 93%RH
Storage Temp	-25 à+70°C, -25 to +700C @ 95%RH
Humidity	Up to 95%RH
Sealing	Fully sealed front, suitable for bulkhead cockpit mounting. Vented barrel to prevent condensation.

ELECTRICAL

Power Supply	12V DC nominal (10 to 16V)
Operating Current	40mA typical, 100mA illuminated
Protection	Connect via external fuse or circuit breaker.

CABLES AND CONNECTIONS

Connection to adjacent units is via cable tails fitted with either a plug or a socket. Extension cables are available from your dealer. The cable tails carry power and NMEA data between units.

ALARM

Internal audible alarm. Control output for external alarm unit.

NMEA OUTPUT SENTENCES

There is no NMEA output from the Network DEPTH unit.